

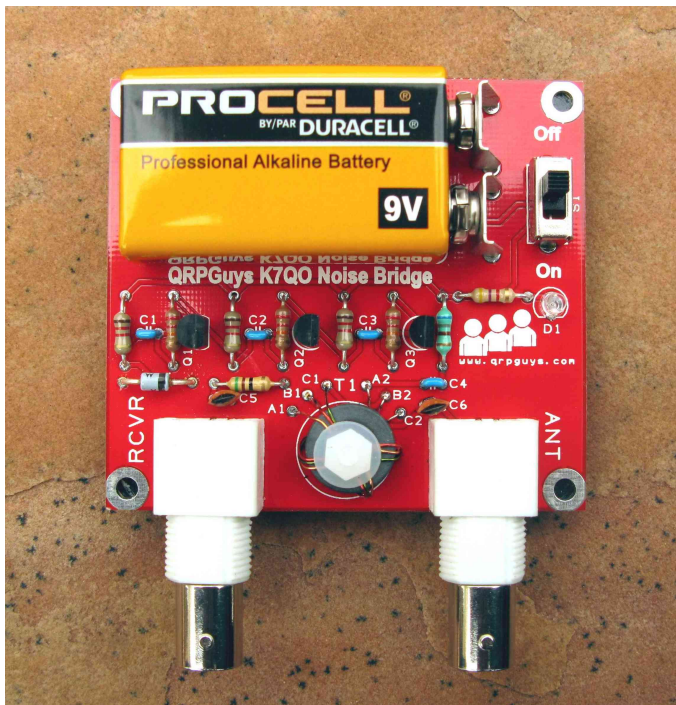

## QRPGuys K7QO Noise Bridge Assembly Manual



First, familiarize yourself with the parts and check for all the components. If a part is missing, please contact us and we will send one. You must use [qrpguys.parts@gmail.com](mailto:qrpguys.parts@gmail.com) to request a part.

### Parts List

- 1 – QRPGuys K7QO Noise Generator PCB
- 3 - Q1, Q2, Q3, 2N3904 transistor
- 1 – D2, 1N4737, 7.5v, Zener diode, small glass diode w/black band on one end
- 1 – Slide switch – SPDT
- 1 – FT50-43 toroid core (black)
- 1 – magnet wire, three colors
- 2 - BNC horizontal PCB female connector
- 1 – 4-40 x 1/2" long nylon screw
- 1 – 4-40 nylon nut
- 1 – 3/8" diameter #4 nylon washer
- 1 – C1, C2, C3, C4, .01uF mono capacitor, marked 103
- 2 - C5, C6, 27pF capacitor, marked 27
- 3– R1, R3, R5, 1.2K ohm, 1/4W resistor (brown-red-red-gold)
- 3 – R2, R4, R6, 22K ohm resistor (red-red-orange-gold)
- 1 – R7, 680 ohm resistor (blue-gray-brown-gold)
- 1 – R8, 4.7K ohm resistor (yellow-violet-red-gold)
- 1 – R9, 51 ohm resistor (green-brown-black-gold)
- 1 - D1, Red LED w/clear lens
- 1 – male 9v battery clip
- 1 – female 9v battery clip
- 4 – self adhesive rubber foot
- 9V battery not included

We will assemble the smallest components first. All the components are installed on the front side of the board. Use the figure below as a guide for locations.

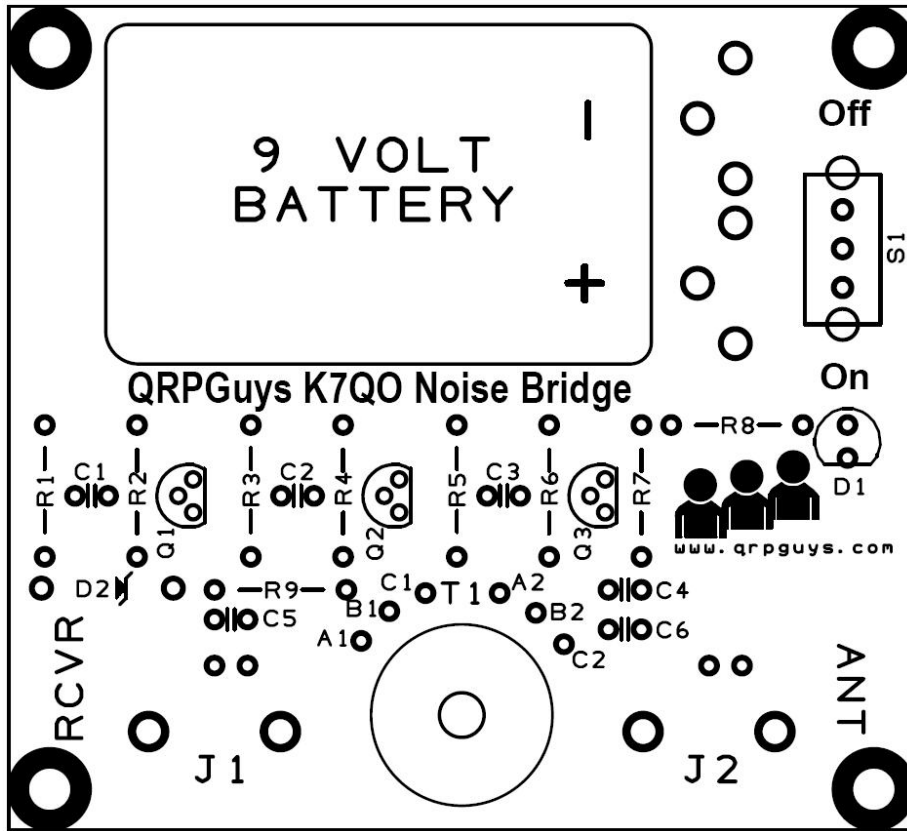

- [ ] Install C1, C2, C3, C4, .01uF, marked 103
- [ ] Install C5, C6, 27pF, marked 27
- [ ] Install D1, the clear lens LED on the front side of the board. The polarity must be correct. The short lead is “negative” and goes towards the bottom of the board. There is also a very small flat indicating the negative side of the led, and a bar silkscreened indicating the flat on the board. Seat the LED flush with the surface of the board.
- [ ] Install D2, 1N4737, 7.5V Zener diode, observing the black polarity band (cathode) location as shown above.
- [ ] Install R1, R3, R5, 1.2K ohm resistor (brown-red-red-gold)
- [ ] Install R2, R4, R6, 22K ohm resistor (red-red-orange-gold)
- [ ] Install R7, 680 ohm resistor (blue-gray-brown-gold)
- [ ] Install R8, 4.7K ohm resistor (yellow-violet-red-gold)
- [ ] Install R9, 51 ohm resistor (green-brown-black-gold)
- [ ] Install Q1, Q2, Q3, 2N3904 transistor, matching the outline on the board.

Next, to assemble is the toroid transformer, T1.

- [ ] Use the FT50-43 (black) core and magnet wire. You are winding a total of **4** turns. Wind all three colors together. Remember, every time the wires goes through the center of the core, it counts as one turn. The figure below shows the completed transformer. Position the wire colors as shown below. "A1" is the same color as "A2" etc. They will correspond to the silkscreened letters on the PCB and must be in this sequence prior to soldering.

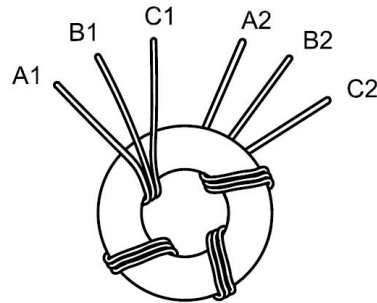

- [ ] Tinning the leads prior to soldering them to the board will greatly eliminate any continuity problems.
- [ ] Solder T1 where indicated on the PCB, with the toroid centered on the screw hole. Install the toroid flush with the board. **Do not elevate it off the board.**

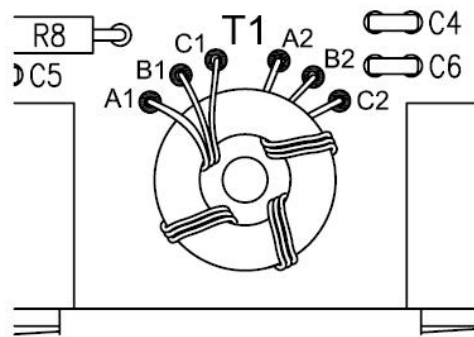

- [ ] Secure T1 to the board using the 4-40 nylon screw, nylon washer, and nylon nut, as shown below. Tighten enough to secure and protect the toroid, but do not over tighten.

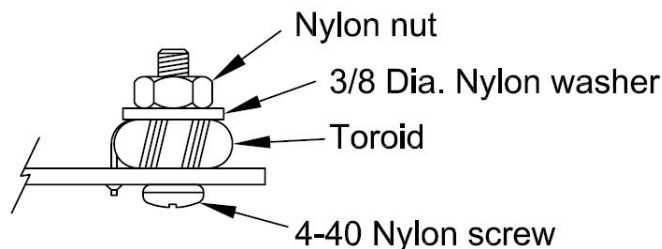

- [ ] Install the slide switch S1.
- [ ] Install the 9 volt battery clips noting the position of the male and female contacts as shown in the figure below. There is no reverse polarity protection diode, so installing these incorrectly will make the device not work and may result in circuit damage.

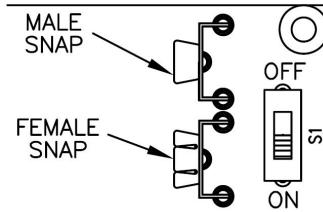

- [ ] Install the two female BNC connectors flush with the board.
- [ ] Install the four self adhesive feet on the back side corners

This completes the electrical and mechanical assembly.

**Schematic:**

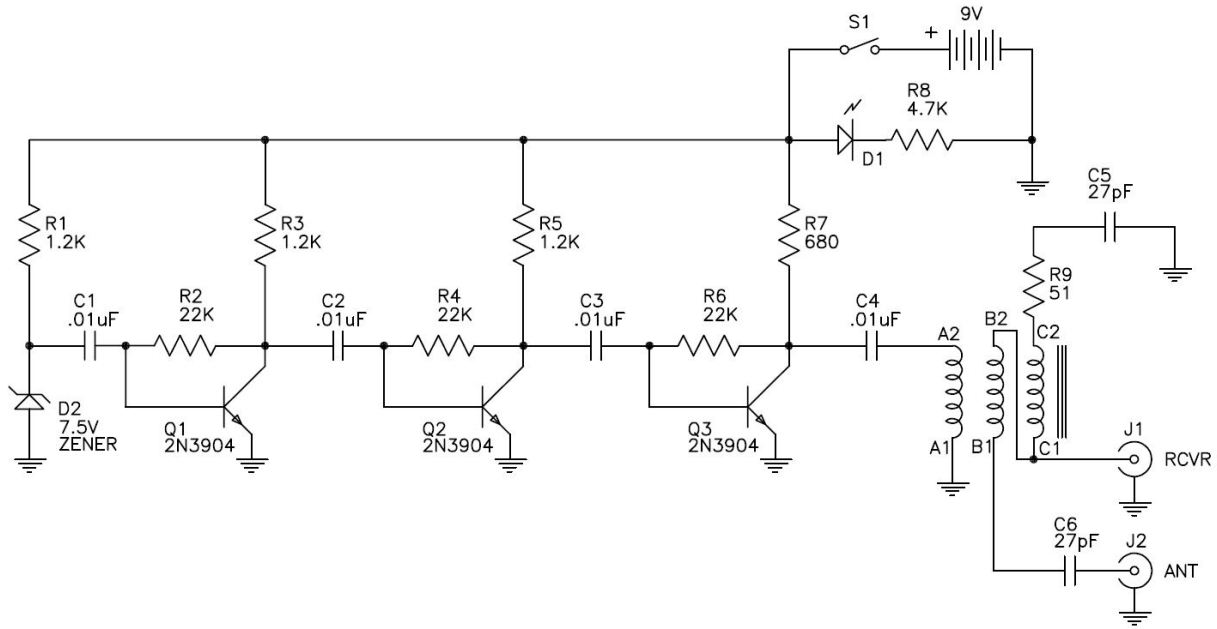

**Notes:**

---



---



---



---



---



---