

QRPGuys Simple RF Probe

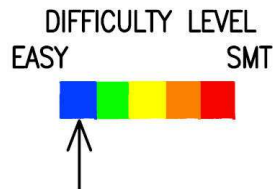
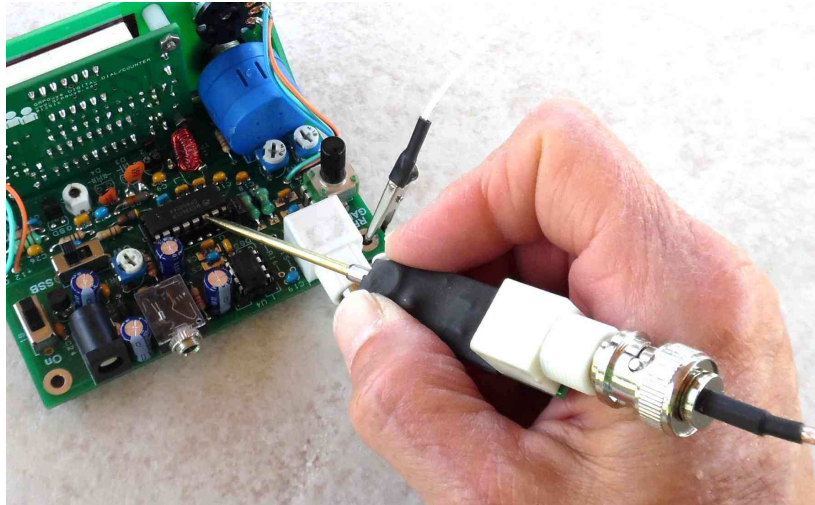

First, familiarize yourself with the parts and check for all the components. If a part is missing, please contact us and we will send one. You must use qrpguys.parts@gmail.com to request a part.

Parts List

- 1 – QRPGuys Simple RF Probe PCB
- 1 – D1, 1N5711 diode, small glass, w/black band on one end
- 1 – R1, 4.7M ohm resistor, yellow-violet-green-gold
- 1 – C1, .01uF mono capacitor, marked 103
- 1 – 3/32" dia. x 2" long brass rod
- 1 - ring terminal, #6 x 14/16ga., non insulated
- 1 – 6-32 x .25"L SS pan head phillips screw
- 1 – 6-32 SS nut
- 1 - #6 lock washer
- 1 – female bnc pcb connector
- 1 – \varnothing 1/2" x 2" long heatshrink tubing
- 1 - \varnothing 3/16" x 1" long heatshrink tubing
- 1 – 12" 24 awg Teflon wire
- 1 – small alligator clip

The tools you will need are a soldering iron with a small tip, .02" or smaller diameter rosin core solder, needle nose pliers, tweezers and side cutters.

Start with the smallest components first, using the figure below as a guide.

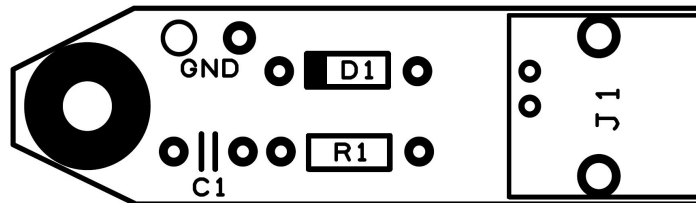

- [] Install C1, .01uF mono capacitor, marked 103
- [] Install R1, 4.7M ohm resistor, yellow-violet-green-gold
- [] Install D1, 1N5711 diode, match the banded end with the silkscreen.
- [] Install the female bnc pcb connector.
- [] Prepare the probe tip as shown in the pictures below. Hold the 3/32" diameter brass rod in an electric drill and file a tapered contact point on one end of the probe tip. You might want to polish the brass rod with a piece of scotchbrite if needed.

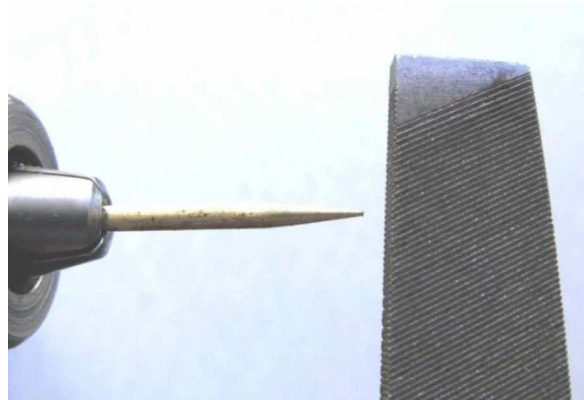

- [] On the other end, if the rod does not fit into the terminal, file down the brass rod to accept the #6 ring terminal, and solder it in place. The brass rod must be clean to solder.

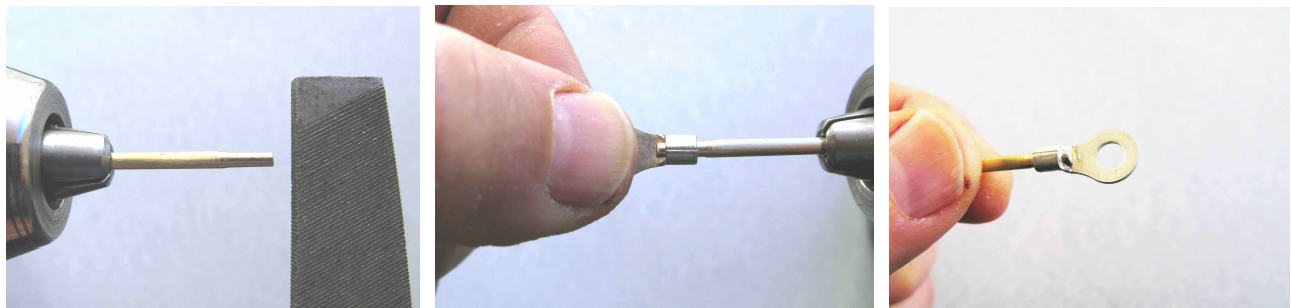

- [] Use the 6-32 hardware and mount the probe tip to the PCB as shown in the figure below.

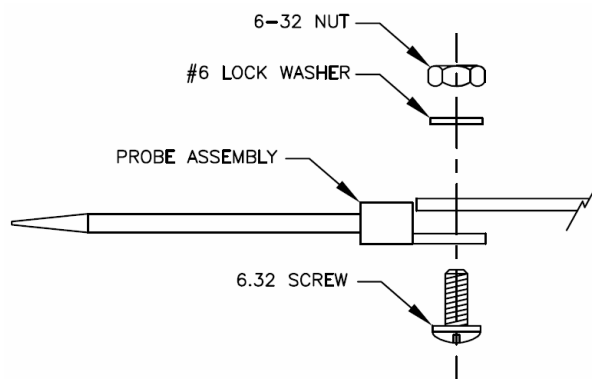

- [] It is best to keep the ground wire as short as possible to prevent receiving spurious signals, 12" is recommended. Solder the teflon ground wire to the GND pad. Route the wire through the hole next to it as a strain relief.

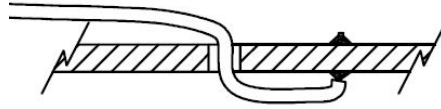

- [] Slip the $\varnothing 3/16$ " heatshrink over the wire and solder the small alligator clip to the end of the ground wire, and slide the heatshrink up to the alligator clip and apply heat to shrink the tubing to the clip .
- [] Slip a 1.5" long piece of the $\varnothing 1/2$ " heatshrink over the assembly up to the bnc connector and heat shrink the tubing to the pcb.



This completes the assembly.

Usage:

One of the best guides for using an rf probe can be found at <http://n5ese.com/rfprobe1.htm>

Schematic:

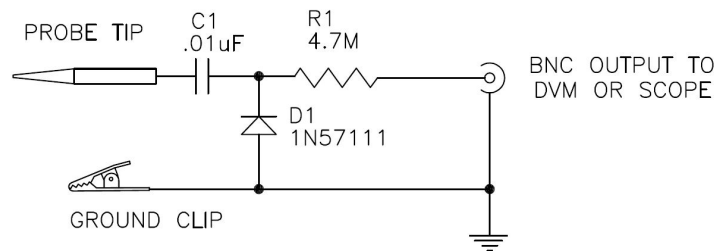

Notes:
